

VS5252C45L6-375 Mid Power UVA LED SMD

VS5252C45L6-375 is a UV LED Surface Mount Device (SMD) offering UV radiation at a peak wavelength of $375 \pm 5\text{nm}$. Each SMD is structured based on the patented 3-PAD LED Flip Chip and unique low temperature bonding technologies to further boost lighting efficiency and decrease the thermal resistance. The VS5252C45L6 series is packaged in a single-chip structure equipped with a 60° lens for mid power UV output.

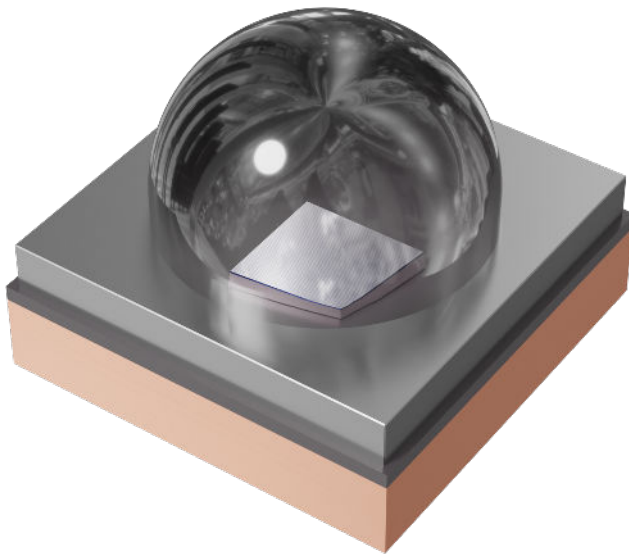

FEATURES & BENEFITS

- Optical output up to 960mW
- Dimensions: 5.2x5.2mm
- Equipped with 60° fused silica lens
- Ideal for mid power applications

THE VIOLUMAS DIFFERENCE

- 3-PAD flip chip structure
- Lowest thermal resistance at 0.9°C/W
- Minimal thermal decay with higher output
- Industry-leading reliability & lifetime

Electro-Optical Characteristics at T=25°C and I_F = 700mA

Parameter	Symbol	Unit	Min	Typical	Max
Peak Wavelength	λ_p	nm	370	375	380
Forward Voltage	V _F	V	-	3.9	-
Radiant Flux	P _O	mW	885	930	960
Full Width of Half Magnitude	$\Delta\lambda$	nm	-	12	-
Radiant Angle	2 $\Phi_{1/2}$	Degree	-	60	-
Thermal Resistance, Junction to Solder Joint	R _{th(J-S)}	°C/W	-	0.9	-

Absolute Maximum Ratings

Parameter	Symbol	Unit	Value
Forward Current	I _F	mA	1000
Reverse Voltage	V _R	V	5
Power	P _O	W	4
Junction Temperature	T _J	°C	115
Operating Temperature	T _{OPR}	°C	-30 ~ 80
Storage Temperature	T _{STG}	°C	-40 ~ 100

Reliability

Test	Condition	Test Duration	Test Failed/Tested
Thermal Shock	-45°C ~ 125°C	2000 Cycles	0/10

Mechanical Dimensions

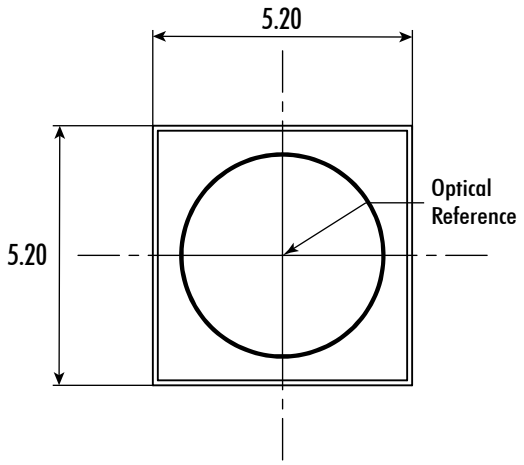

Top View

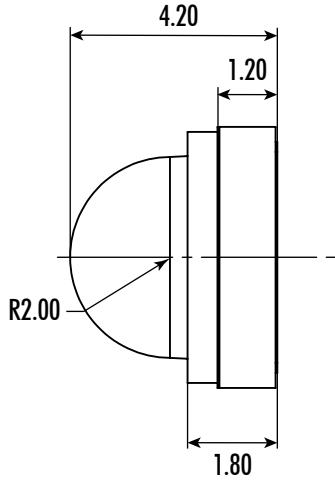

Side View

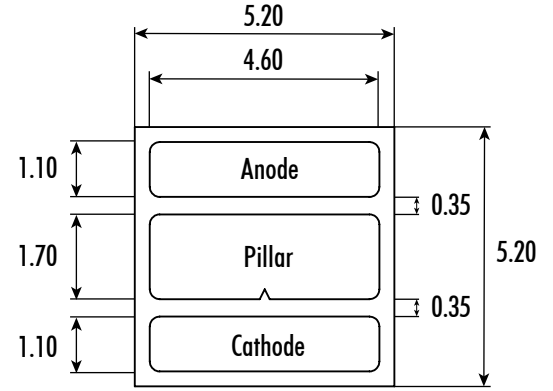

Bottom View

Radiation Pattern

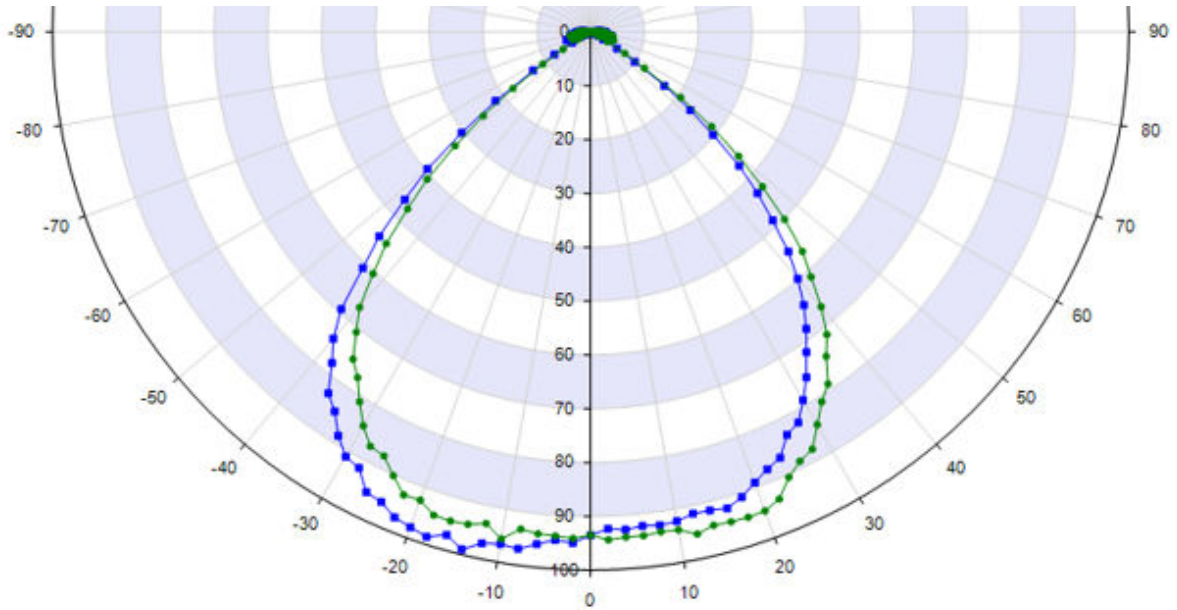

Spectral Output

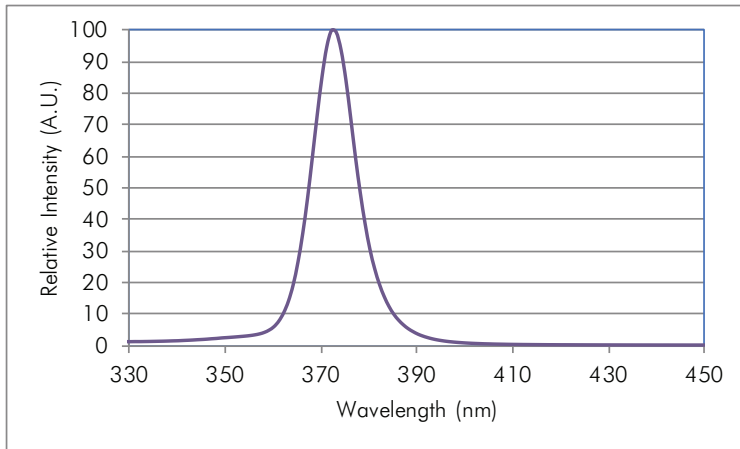

Forward Current vs. Relative Radiant Flux

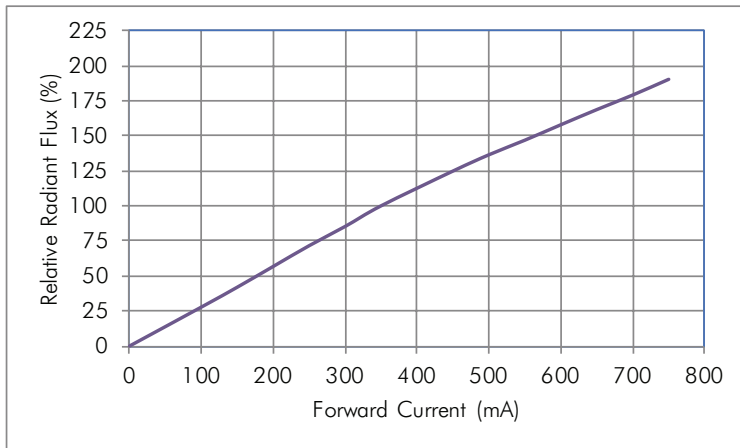

Forward Voltage vs. Forward Current

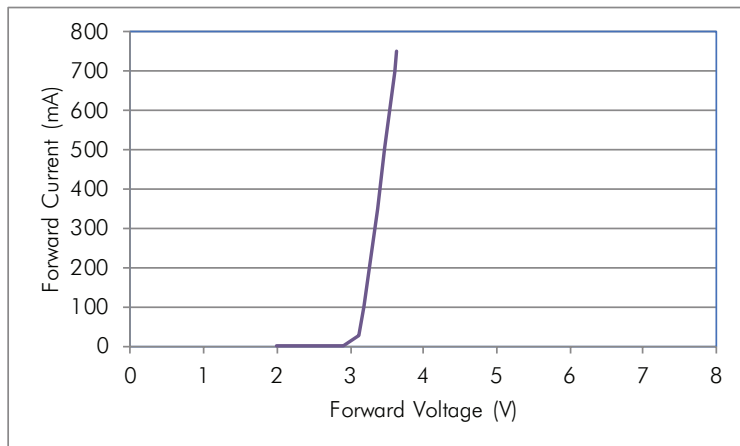

Soldering Guidelines

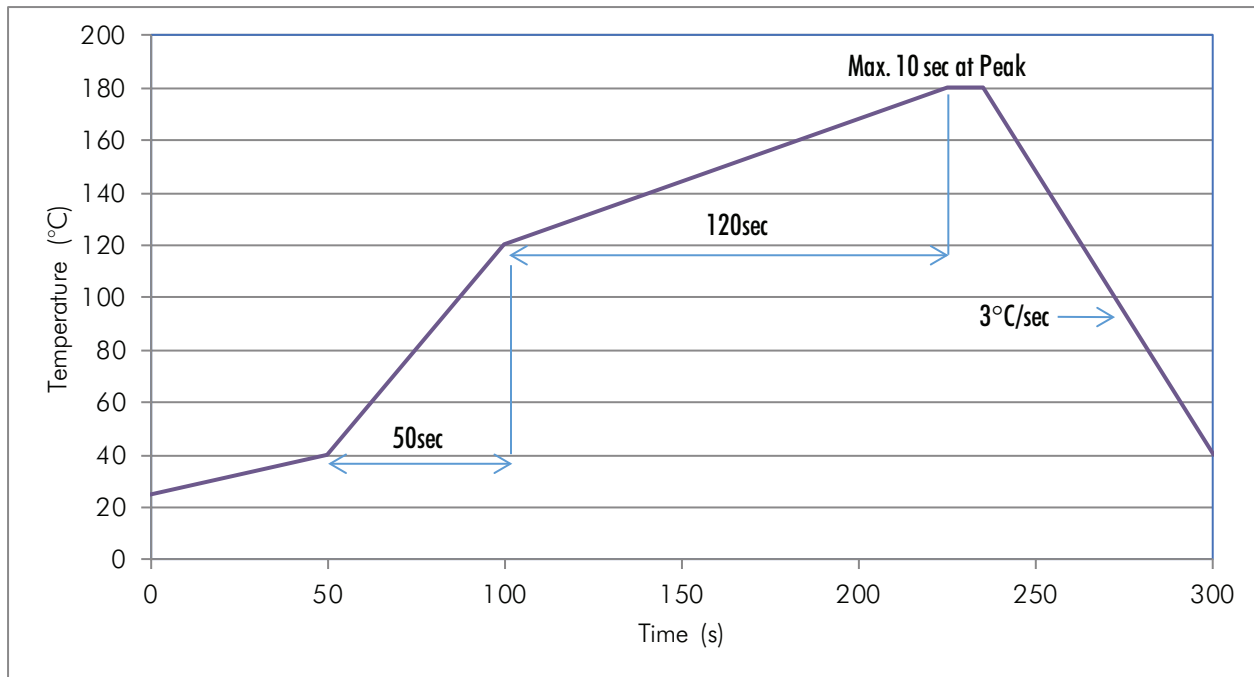

Recommended MCPCB

Violumas recommends the use of the Pillar MCPCB with Violumas LEDs for maximum performance and reliability. The data presented in this document is measured from the use of exclusive Flip Chip Opto patented products - the 3-PAD LED Flip Chip and the Pillar MCPCB. Please consult the Violumas engineering team for further recommendations on MCPCB options.

Handling & Usage Precautions

- Exhibit extreme care when handling LEDs. Do not touch the LED with bare hands as doing so may contaminate and affect the optical characteristics of the LED. When using tweezers, do not apply excessive force, especially to the glass lens. Do not drop the LED as doing so may cause product damage.
- Ensure that electrostatic discharge specifications are followed. Static electricity and surge voltages may cause product damage. Proper electrostatic discharge protection equipment, working machinery, and protected mounting equipment are recommended.
- Do not expose the LEDs to volatile organic compounds as well as hazardous, acidic, and corrosive substances during storage and operation to avoid product damage.
- Do not apply excess mechanical force and vibration while handling the product.
- Do not expose the product to sudden changes in temperature, high humidity levels, and condensation.
- Ensure that the PCB is suitable for the product and be wary of LED placement and possible PCB warpage.
- To avoid fault issues, do not couple any electrical wires to the metal substrate of the MCPCB or COB. If any electrical wires from the power source have contact with the MCPCB's metal base under power ON conditions, permanent damage may occur due to inner arcing within the 3-PAD LED structure.

Storage Precautions

- Perform soldering as soon as the moisture-proof packaging is opened.
- After the storage duration has exceeded the recommended time, products may need to be baked before soldering.
- Store all products in a controlled environment under 30° C free of dust. Do not expose the product to sudden changes in temperature, high humidity levels, and condensation.
- Please consult the Violumas engineering team for further information on storage precautions.

Eye Safety Precautions

- Avoid exposure to UV light during LED operation. Do not look directly into the UV light during LED operation. Do not look directly into the UV light during optical measurements even through optical instruments. Protect the body, skin, and eyes with UV protective equipment.
- Attach warning labels on all products and systems that use UV LEDs.

Cleaning Precautions

- Do not use brushes or organic solvents for cleaning the LEDs.
- Perform electrical and optical measurements before and after cleaning to ensure optimal performance.

Static Electricity Precautions

- Ensure that equipment and machinery are properly grounded.
- Anti-electrostatic attire (wristbands, gloves, footwear, etc.) is recommended.
- Damage inspection is recommended while performing characteristics inspection of LEDs.

Disclaimers

Violumas is not responsible for any damages that result from inaccurate use of the recommended guidelines. The information compiled in this document is a result of careful review of reference materials and reliable sources. Violumas does not make any claims regarding warranty or guarantee. It is recommended that each customer consults the Violumas engineering team before engaging Violumas products in extreme applications where the failure of the LED and damage to human health may be possible. Each user assumes full responsibility for determining the suitability of the use of Violumas products in various applications. Disassembling Violumas products without consent is prohibited. No part of these documents may be reproduced in any form without prior written permission from Violumas. Please note that the data presented in this document is measured from the use of exclusive Flip Chip Opto patented products - the 3-PAD LED Flip Chip and the Pillar MCPCB.